



# PRODUCT CATALOG (3MVA-30MVA) OIL IMMERSED TRANSFORMER

version 2024-11EN

IEC 60076 Series;  
GB 20052-2020, GB 1094-1996,  
GB / T 6451-2008, GB / TT7597-2007,



## HENGFENGYOU ELECTRIC GROUP

Smart Electric Global Service provider

Make life better!



[www.hengfengyou.com](http://www.hengfengyou.com)

# CATALOGUE

▪ Company profile	01
▪ Certificate	02
▪ Product overview	03
▪ Product advantage	04
▪ Our factory	07
▪ Technical Parameter	10
▪ Quality control	12
▪ TEST	13
▪ Installation	14
▪ Service	17



## ABOUT HENGFENGYOU ELECTRIC GROUP

HENGFENGYOU ELECTRIC GROUP, is an electrical enterprise with transmission and distribution industry as its main business, integrating product research and development, manufacturing and trade. Designated suppliers for the world's top 500 enterprises. Its main products include power transformers, medium and low voltage switchgear, distribution panel, circuit breakers, transmission tower, Cable and other power distribution equipment. The group has five departments: Transformer department, Panel department, power transmission tower department, cable department and electrical engineering department. HENGFENGYOU ELECTRIC GROUP has been working hard to provide the best transmission, distribution solutions for users all over the world.

### Key figures

- Since: 1990
- Revenue in 2018: 635 million (RMB)
- 550 employees and 30 Electrical Engineers
- 6 production sites in China
- 6% of revenue is invested in R &D

### Power distribution solutions that drive the global energy transition

With energy demand expanding in both developed and emerging countries, the challenge for HENGFENGYOU ELECTRIC GROUP is to connect energy with people. The group's teams work as closely as possible with projects and decision makers and design and propose technical and process solutions based on global user needs.



Qingdao Hengfengyou Electrical Engineering Co., Ltd  
Address: N0.638 Zhongcheng Road, Chengyang District, Qingdao City, China  
Tel: +86-532--87936206  
Website: <http://www.hengfengyou.com>  
Sales: [hfy@hengfengyou.com](mailto:hfy@hengfengyou.com) Service: [service@hengfengyou.com](mailto:service@hengfengyou.com)



## QUALIFICATION CERTIFICATION



## OUR PARTNER



## 🕒 PRODUCT OVERVIEW

HENGFENGYOU ELECTRIC has the production capacity of high-power distribution transformers below 3-36kV/30MVA, with an annual production capacity of 100MVA. High power distribution transformers are widely used in oil fields, metallurgy, chemical industry, mines, docks and other places.

-We use high-quality copper wire coils and silicon steel sheets, equipped with a more efficient cooling system, lower losses, and a high work efficiency of  $\geq 99.3\%$ .

-Featuring good stability, reliable quality, and long lifespan, it can operate stably in various harsh environments.

-The actual measurement of the product is superior to GB and IEC standards, CB CCC KEMA SASO certification, etc-The high reliability of operation verification in more than 50 countries and regions around the world has been sold to Iraq, Kuwait, the United Arab Emirates, Libya, Zimbabwe, South Africa, Uganda, Rwanda, Ethiopia, Ghana, Uzbekistan, Kazakhstan, Pakistan, Vietnam, Nepal, Bangladesh, Indonesia and other countries, with a cumulative export of 3598 sets

-It is mainly used in urban distribution network below 35KV, power supply and distribution system of industrial and mining enterprises and civil buildings-Executive Standards: IEC 60076 Series, IEC 6013, IEC 60214-1, IEC 60296; GB 1094-1996, GB / T 6451-2008, GB / TT7597-2007, etc



33kv-3150kvaOil immersed transformer

## 🕒 PRODUCT ADVANTAGE

### Leading technology

- High voltage copper tape winding technology to improve lightning resistance
- Low voltage copper foil winding technology, high quality A grade insulation material insulation
- Small magnetic leakage, high mechanical strength, short circuit resistance
- Core 45° fully inclined joint step laminated structure



20kV/3mva oilfield specific transformer

### The shell

- ABB robot automatic welding, laser detection, avoid leakage, pass rate of 99.99998%
- Electrostatic spray treatment, 50 years without removing paint (coating corrosion resistance within 100h, hardness  $\geq 0.4$ )
- Fully sealed structure, maintenance free, normal operation service life of more than 30 years

### The iron core

The iron core is made of high quality cold-rolled grain oriented silicon steel sheet with mineral oxide insulation (from Baosteel and WISCO of China).

By controlling the cutting and stacking process of silicon steel sheet, the loss level, no-load current and noise can be minimized. The iron core is specially reinforced to ensure the structure of the transformer is firm during normal operation and transportation.



# PRODUCT ADVANTAGE

## Winding

The low voltage winding is made of high quality copper foil with excellent insulation resistance

High voltage winding is usually made of insulated copper wire, using hengfengyou electric patented technology

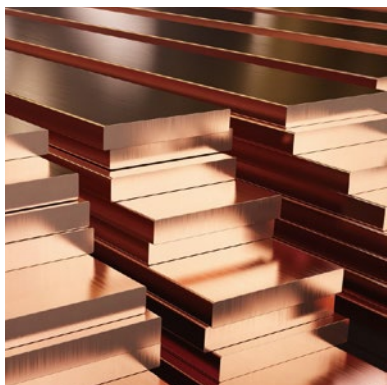
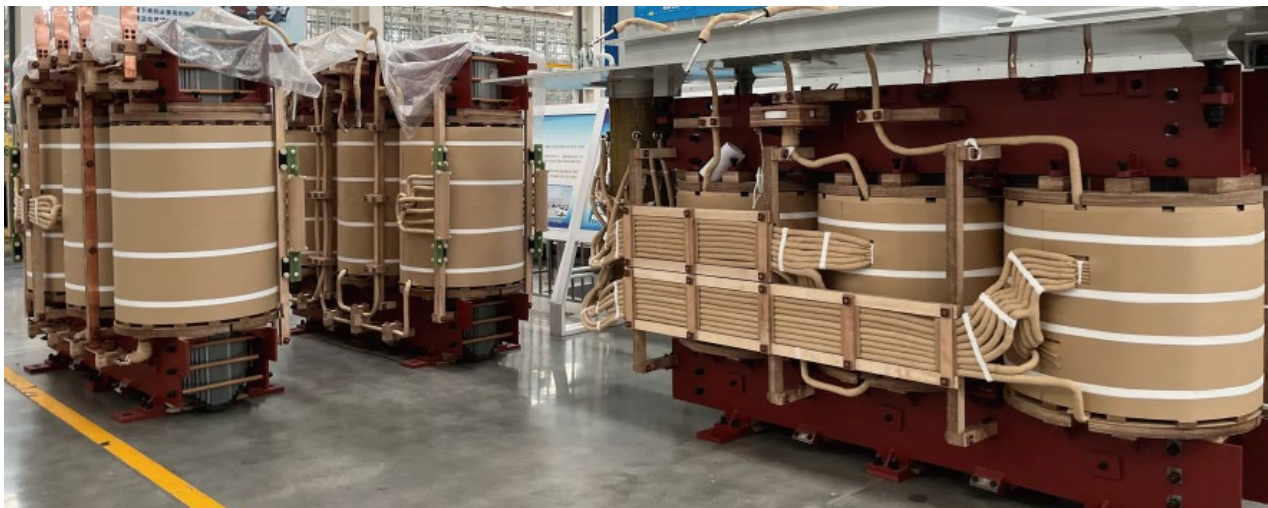

### High quality material

Baosteel and WISCO produce silicon steel sheets

China's high quality oxygen free copper

CNPC (Kunlun Petroleum) High quality transformer oil (25#)

### Patent technology

Thanks to hengfengyou Electric "ultra-low loss energy-saving power transformer" patent technology, can achieve 5% material savings, transformer loss than similar products in the market reduced 10-20%, more energy saving and environmental protection.



### Other instructions

The low-voltage outlet terminal is a tin-plated copper bar

High voltage outlet terminals are tin-plated ring bolts

Default no-load voltage regulation (can be customized) tap switch 5 or 7 gear adjustment

Transformer above 630KVA is equipped with gas relay protection.

## 🌱 PRODUCT ADVANTAGE

### Leading technology

-High voltage copper tape winding technology to improve lightning resistance

Low voltage copper foil winding technology, high quality A grade insulation material insulation

-Small magnetic leakage, high mechanical strength, short circuit resistance

-Core 45° fully inclined joint step laminated structure



### The shell

- ABB robot automatic welding, laser detection, avoid leakage, pass rate of 99.99998%
- Electrostatic spray treatment, 50 years without removing paint (coating corrosion resistance within 100h, hardness  $\geq 0.4$ )
- Fully sealed structure, maintenance free, normal operation service life of more than 30 years

### The iron core

- The iron core is made of high quality cold-rolled grain oriented silicon steel sheet with mineral oxide insulation (from Baosteel and WISCO of China).
- By controlling the cutting and stacking process of silicon steel sheet, the loss level, no-load current and noise can be minimized
- The iron core is specially reinforced to ensure the structure of the transformer is firm during normal operation and transportation



20kV/3MVA oilfield specific transformer



## 🔄 OUR FACTORY

The company mainly produces more than 300 sets of equipment, and the key equipment includes the full-automatic vacuum resin casting equipment of Hubers company, 400 / 600mm core automatic cross cutting machine, foil winding machine, the most advanced transformer kerosene vapor phase drying equipment in China, large-scale core stacking turnover platform, large scale assembly platform, etc



**SILICON STEEL SHEET CROSSCUTTING MACHINE**



## OUR FACTORY

Hengfengyou Electric has 22000 square meters of modern plant, with a monthly delivery capacity of up to 500 distribution transformers, and has fully passed the ISO9001, ISO14001, SA8000, BSCI and other market access standards reviewed and issued by international certification bodies. At present, the company has 10 senior engineers, 30 senior technicians and more than 300 employees, with an annual output value of US \$100 million.

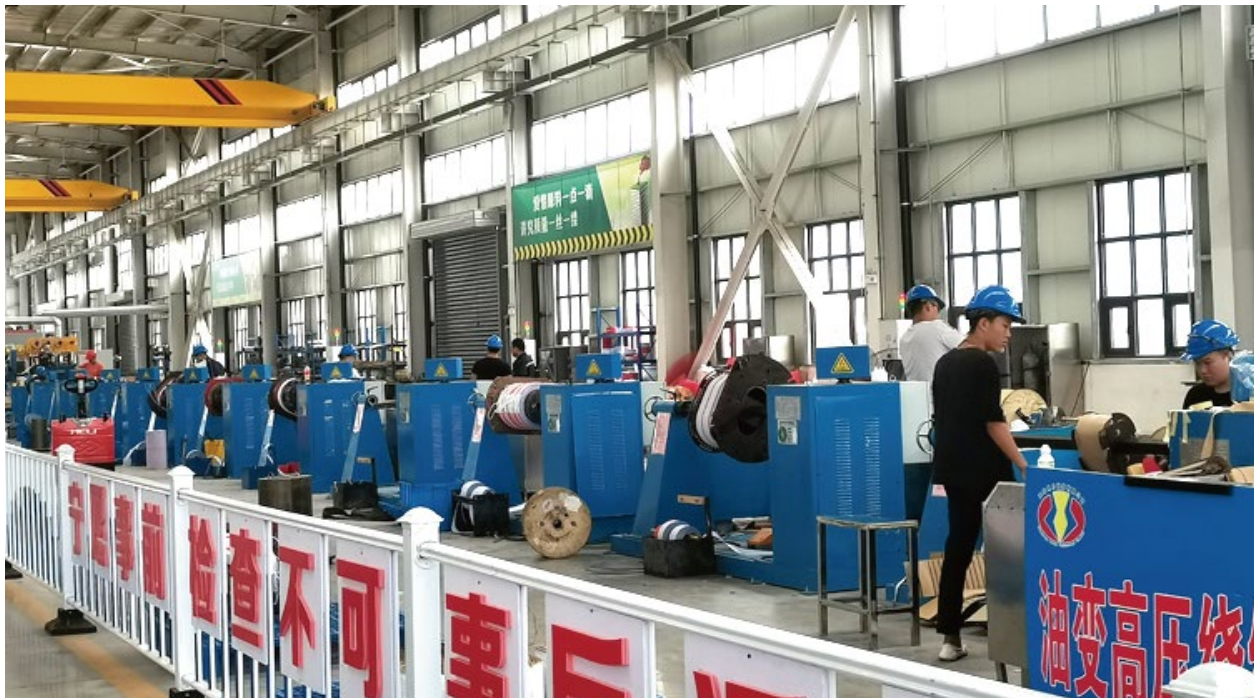

# FLUID FILLED DISTRIBUTION TRANSFORMER

Type of transformer	Hermetically seal liquid fille (optional conservator)
Style of transformer	Ground Mounted - Cable or busbar Connected
Choice of dielectric fluid	Mineral oil to IEC60296 (KUNLUN25#)
Ratings	3mva up to 30mva
Voltages	Up to 36kV (6/10/35kv 6.6/11/33kv 20/22kv 15/30kv)
Losses	GB 20052-2020 (Officially implemented on June 1, 2021)
Availability	Fast Transformer STOCK (choice of aluminium or copper windings) manufacture – 7 weeks

Standard Tank Fittings	Optional Tank Fittings
Oil level indicator	Fluid-filled conservator
Rating and diagram plate	Gas & fluid actuated relay
Off circuit tap changer	Pressure relief device
pressure relief valve	Dehydrating breather
Dial thermometer	Liquid temperature indicator
Earth terminal	Winding temperature indicator
Filling valve	Marshalling box
Drain valve	Vacuum / pressure gauge
Lifting lugs	Plain rollers and axles
Earthing terminals	

CUSTOMER-ORIENTED CREATE VALUE FOR CUSTOMERS  
MAKE FRIENDS ALL OVER THE WORLD

# TECHNICAL PARAMETERS

## S11 OLTC Oil-immersed Transformer

Rating (kva)	High voltage (kV)	High voltage tap range (%)	Low voltage (kV)	connection symbol	No-Load Loss	Load Loss (kw)	No-Load current(%)	Short current impedance(%)	
2000	20	$\pm 3 \times 2.5\%$	6	Yd11	2.3	19.2	0.5	6.5	
2500					2.72	20.6	0.5	6.5	
3150					3.23	24.7	0.5	7	
4000					3.87	29.1	0.5	7	
5000					4.64	34.2	0.5	7	
6300					5.63	36.7	0.5	7	
8000			34.5	10	Yd11	7.87	40.6	0.4	8
10000			9.28			48.0	0.4	8	
12500			10.9			56.8	0.35	8	
16000			13.1			70.3	0.35	8	
20000			15.5			82.7	0.3	8	
25000			18.3			97.8	0.3	10	
31500	38.5	12	Yd11	21.8	116	0.3	10		

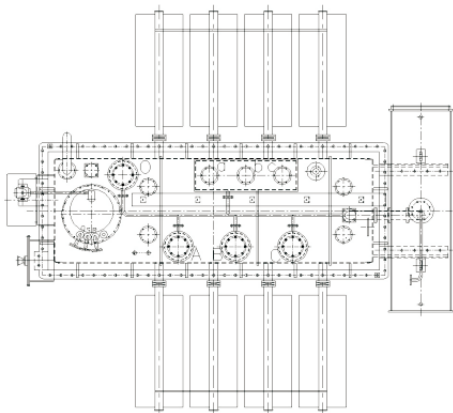
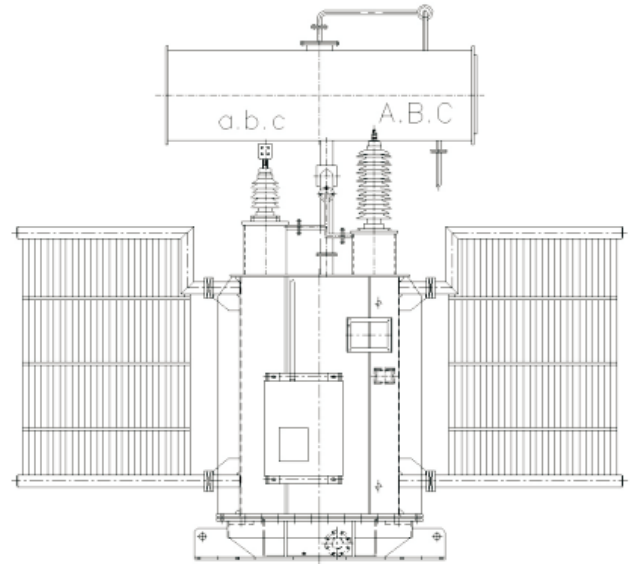
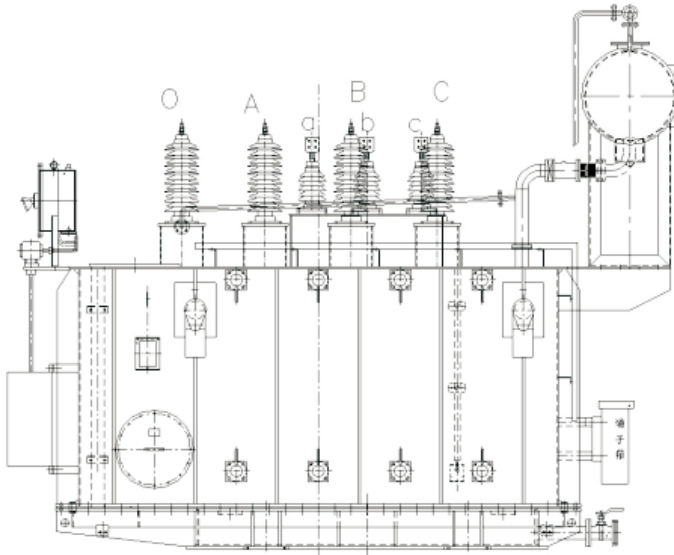

# TECHNICAL PARAMETERS

S11 OCTC Oil-immersed Transformer

Rating (kva)	High voltage (kV)	High voltage tap range (%)	Low voltage (kV)	connection symbol	No-Load Loss	Load Loss (Kw)	No-Load current(%)	Short current impedance(%)				
630	20	$\pm 2 \times 2.5\%$	6	Yd11	0.83	7.86	0.65	6.5				
800					0.98	9.4	0.65	6.5				
1000					1.15	11.5	0.65	6.5				
1250					1.4	13.9	0.55	6.5				
1600					1.69	16.6	0.45	6.5				
2000					2.17	18.3	0.45	6.5				
2500					2.56	19.6	0.45	6.5				
3150					22	$\pm 2 \times 2.5\%$	6.6	Yd11	3.04	23	0.45	7
4000					33				3.61	27.3	0.45	7
5000					34.5				4.32	31.3	0.45	7
6300					35				5.24	35	0.45	7
8000					38.5				7.2	38.4	0.35	8
10000					8.7				45.3	0.35	8	
12500					10				53.8	0.3	8	
16000					12.1				65.8	0.3	8	
20000					14.4				79.5	0.3	8	
25000	17	94	0.25	10								
31500	20.2	112	0.25	10								

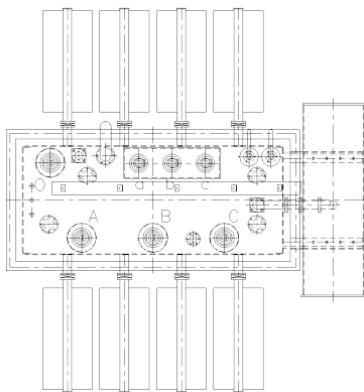
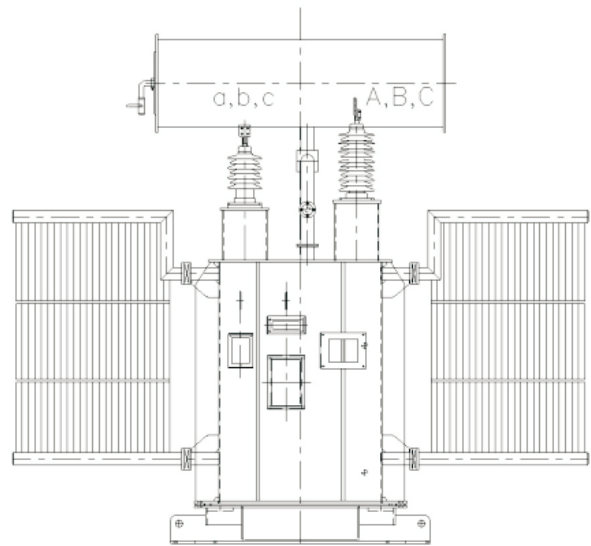
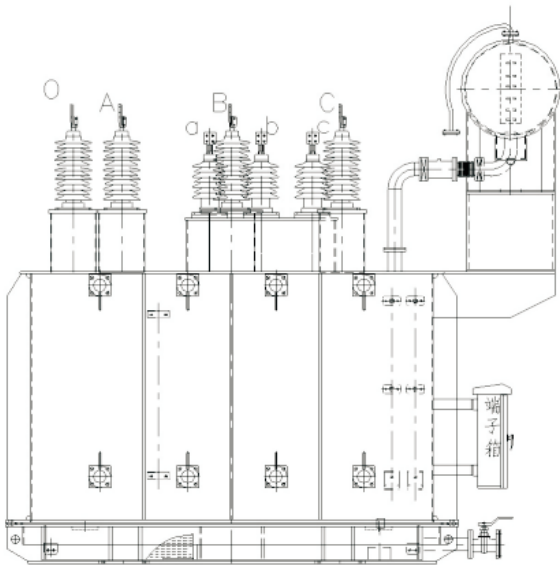

# QUALITY CONTROL:

We have established strict SQA working procedures and ISO standards in the development, production, sales and after-sales of electrical products, so as to provide customers with first-class products and the best service.

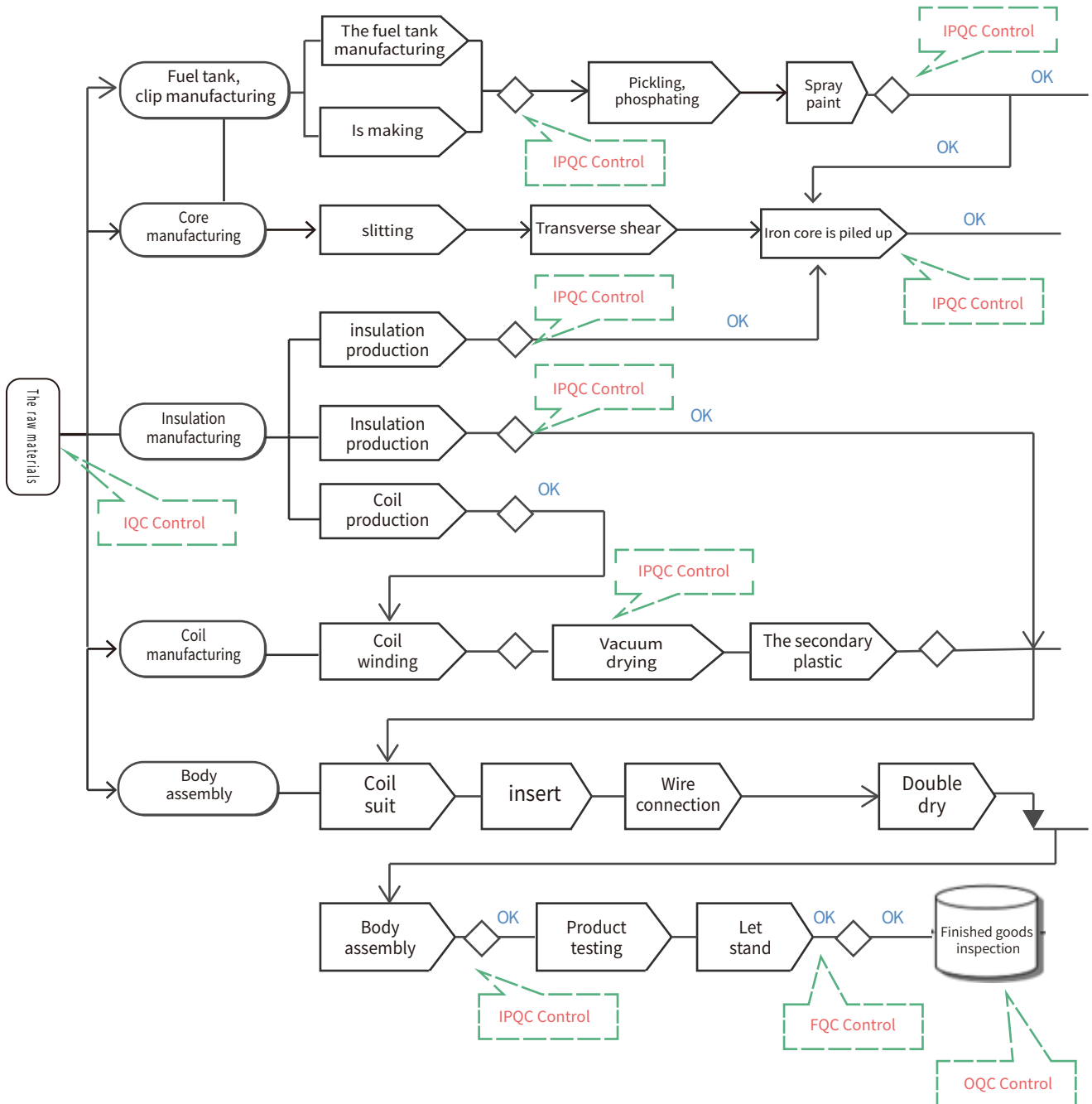

SQA MANAGEMENT OF OIL IMMERSSED TRANSFORMER

## TEST



Comprehensive experimental platform for power transformer

### Delivery test (or routine test)

These tests verify the electrical performance specified in the contract. And submit a formal test report.

### characteristic measurement

- Winding resistance;
- Transformation ratio and vector group;
- Impedance voltage;
- Load loss;
- No load loss and no-load current.

### insulation test:

- Power frequency withstand voltage test- Inductive voltage withstand test.
- Partial discharge measurement ensures that the expected service life of transformer less than 5pc is closely related to the initial partial discharge level measured during manufacturing.

### Special test

These tests will be arranged at customer's request at customer's expense.

### Short circuit test

These tests were carried out on a special test bench in accordance with IEC 60076-5.

A total of three tests were performed on each transformer column, each lasting 0.5 seconds.

### Noise level measurement

- Noise level measurement is part of a special test.
- Transformer noise is mainly caused by magne

### tostriction of magnetic circuit.

- Noise levels can be expressed in two ways:

Sound pressure level  $L_p$ , measured in accordance with IEC 551 at 1m from the transformer in no-load operation



Noise testing chamber



Transformer test

# INSTALLATION

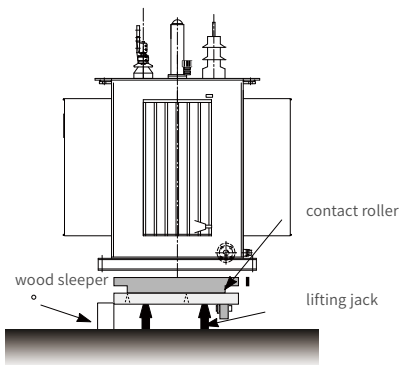
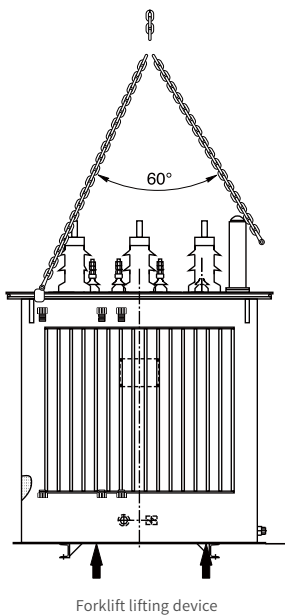

## carry

Use the 4 lifting lugs of the transformer (it must be lifted vertically, not obliquely); For the transformer with 2 lifting lugs in the center of the top of the shell, use 2 lifting lugs. The included angle formed by the sling shall not be greater than 60°.

First, check the forklift's forking capacity. If appropriate, the fork arm shall be inserted into the base channel after removing the roller.

The transformer with or without enclosure shall be hauled from the base. For this purpose, holes with a diameter of 27mm are opened on each side of the base. It can be dragged from two directions: the axial direction of the base and the direction perpendicular to this axis.

## storage

Hengfengyou transformer shall avoid being polluted by dripping water and sand dust (such as masonry and sand blasting) during storage. If hengfengyou transformer is supplied with a plastic cover, it shall be covered on the equipment during storage. Hengfengyou transformer can be stored in an environment with a minimum room temperature of - 25 ° C and a maximum room temperature of 50 ° C.

No gas or conductive dust that seriously affects the insulation of the transformer; No explosion hazard, no corrosion of electrical components

## LOGISTICS SHIPMENT





## © INSTALLATION

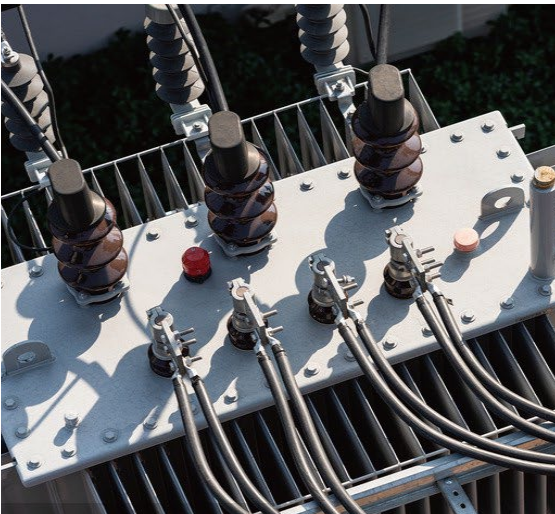

### INSTALLATION SITE

· The transformer shall be installed in a dry, flat place where water is not easy to enter. The installation site shall have sufficient ventilation to ensure that all heat of the transformer can be dissipated

· No load shall be supported anywhere on the enclosure except the power supply cable of the transformer. In addition to correctly installing the connecting cable according to the relevant drawings, facilities or accessories not supplied by the manufacturer or without permission are not allowed to be installed in the shell, otherwise, the user shall bear the risk. For the transformation, connection and installation of any accessories, please consult our hengfengyou technicians.

· The embedded parts, reserved holes, etc. have been cleaned and adjusted to meet the design requirements.

· Protective mesh doors, railings, and other safety facilities are complete, and ventilation and fire protection facilities are installed.

# © INSTALLATION

## INSPECTION BEFORE OPERATION

1. The transformer body and accessories are free from defects, oil leakage, and kept clean.
2. Is the nameplate, voltage level, wiring group, tap position and operation mode, cooling conditions, etc. of the transformer consistent with the actual situation.
3. Whether the connection of the incoming and outgoing lines is firm and reliable, whether the phase color of the transformer casing is correct, and whether the transformer casing is reliably grounded.
4. The tap position of the transformer is in the normal voltage range.
5. Is the valve between the oil conservator and the gas relay open; Whether the oil level and color of the oil level gauge are normal; Is there any gas in the gas relay protector.
6. Check whether the transformer respirator is unobstructed and whether the silicone of the moisture absorber is ineffective and discolored.
7. Is the pressure relief valve blocked and functioning properly.
8. Measure the insulation resistance of the transformer winding and bushing with a megohmmeter, and the insulation resistance value should not be less than 70% of the product's factory test value.



## INSPECTION IN OPERATION

Under normal use and environmental conditions, check the transformer once a year, dust around the transformer and accessories, and fasten lead terminals, pins, grounding screws, connecting bus screws, etc.

## 🕒 PRE-SALE SERVICE:

1. ISO certified excellent Manufacturer
2. Third-party authoritative certifications: CE, CB,UL, CSA etc
3. Flexible payment: T/T, LC,
4. Sufficient inventory, fast delivery time and long validity of the price
5. The whole process of picture tracking can be realized in production and transportation
6. Experienced professional sales team and a strong technical team
7. Sincerely invite customers to visit the company for guidance

## 🕒 AFTER-SALES SERVICE:

1. If there is any quality problem after receiving the goods, you can return the goods free of charge or ship new products
2. We provide our customers with a 1-year product warranty
3. Provide 24-hour, 365-day technical guidance worldwide
4. The VIP customers enjoy our promotional activity  
trained by management consultants, is able to provide professional solutions for customers.
4. Our technical team is ready for 24-hour technical support worldwide.
5. Our customer service team ensures on time delivery.



Call Us For Details



HENG FENGYOU<sup>®</sup>

· Make Life Better ·

智能电气全球服务提供商, 让生活更美好

SMART ELECTRIC GLOBAL SERVICE PROVIDER, MAKE LIFE BETTER

## QINGDAO HENGFENGYOU ELECTRICAL ENGINEERING CO., LTD

Tel: +86-532--8793 6206

WhatsApp: JACK +86 158 5325 2696 MARTIN +86 135 8926 2999

Website: <http://www.hengfengyou.com>

Email: [hfy@hengfengyou.com](mailto:hfy@hengfengyou.com)

[service@hengfengyou.com](mailto:service@hengfengyou.com)

Address: No.638 Zhongcheng Road, Chengyang District, Qingdao City, China

